

IRWIN®

Wood Drilling













www.irwin.com

A Century of Quality and Innovation

In 1885, the IRWIN® Auger Bit Company was formed. Over 125 years later, IRWIN is still the leading manufacturer of wood drilling bits and accessories. No matter what wood drilling project you face, IRWIN Tools makes a drill bit that performs the job better. Our mark of quality is stamped right on the shank of our full range of bits. Whether the job requires quick, clean holes, or precise finish work, IRWIN has a bit for every application and every need.

The all new IRWIN SPEEDBOR® with Weldtec™ Ship Auger Bits are MADE STRONGER and LAST LONGER. With a patent-pending WeldTec cutting edge, these bits are durable, and have twice the nail cutting life of traditional ship auger bits. The bits are fully forged, for added durability; have an aggressive screw pitch for faster drilling; and wide flutes for maximum chip removal. Only IRWIN offers the superior performance and added durability of WeldTec.

Use the chart below to determine which bit is best for the job at hand.

Bit Style	Size Range	Typical Trades	Application Benefits
 Tri-Flute Bit	7/16" to 1-1/2" diameter	Carpentry, Electrical, Plumbing	Fast, clean holes with reduced "break out" when through-hole drilling. Full-screw tip requires less effort.
 Spade Bit	1/4" to 1-1/2" diameter 4-3/4" to 16" lengths	Carpentry, Electrical, Plumbing	Fast, clean holes with reduced "break out" when through-hole drilling.
 Spurred Solid Center Auger Bit	1/4" to 1-1/2" diameter 7-1/2" length	Carpentry, Electrical, Plumbing	Self-feeding tip pulls bit into the work for repetitive cutting of fast clean holes with a clean exit hole. Single-spur cutting edge scribes the circumference of the hole for a smoother finish.
 Ship Auger Bit	3/8" to 2" diameter 7-1/2" to 29" lengths	Public Utilities, Electrical, Plumbing, Carpentry, Log Homes	Hollow center provides better chip removal for deeper holes in utility poles and logs.
 Installer Bit	1/4" to 3/4" diameter 12" to 30" lengths	Telecommunications, Cable/Internet, Security Systems	Wire hole near the end of the bit enables user to pull wire back through after drilling the hole.
 Self-Feed Bit	1" to 4-5/8" diameter	Plumbing, Electrical, General Contracting	Replaceable self-feeding tip pulls bit into the wood. For cutting larger holes with clean edges.
 Forstner Bit	1/4" to 2-1/8" diameter	Fine Woodworking, Cabinet Making	Precise cutting of smooth, flat-bottomed (blind) holes with clean, sharp edges.
 Brad Point Bit	1/8" to 1/2" diameter	Woodworking, Cabinet Making	Precise cutting of smooth through-holes with clean, sharp edges and reduced "break out."
 Countersink Bit	1/8" to 1/2" diameter	Woodworking, Cabinet Making	Perfect for variable-size countersink holes.
 Plug Cutters	1/8" to 1/2" diameter	Woodworking, Cabinet Making	Perfect for cutting dowels or plug holes.
 Quick Change Extensions	1/4" available in 2", 6" and 12" length 3/8" available in 2", 5-1/2" and 12" length 7/16" available in 5-1/2", 12" and 18" length	Woodworking, Cabinet Making	Lock-n-Load one-handed quick release.

SPEEDBOR® Max Speed Bits

SPEEDBOR MAX SPEED BIT FEATURES

1. Full-screw tip allows bit to self-feed.
2. Three cutting spurs for faster, cleaner holes.
3. Tri-flute design for faster chip ejection.
4. Grooved hex shank prevents slipping in drill chuck or bit extension, and fits all standard 1/4" quick change chucks.*

*3/8" for 1-3/8" and 1-1/2" bits

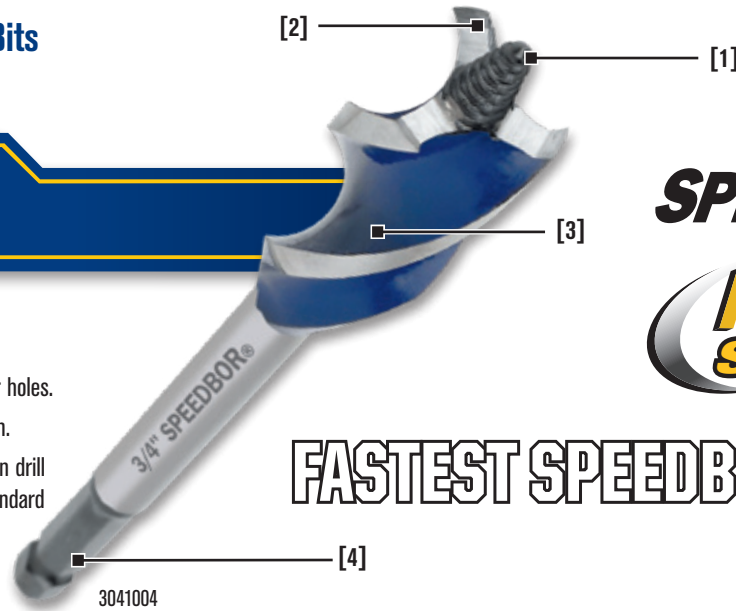

FASTEST SPEEDBOR EVER®

6-piece SPEEDBOR MAX Speed Set



3041006

3-piece SPEEDBOR MAX Speed Set



3041003

Quick Change Extension



4935704

Diameter	Length	Shank Size	U.S. Item#	Canadian Item#	Pack Qty	Bulk Item #	Pack Qty
7/16"	6"	1/4" Hex	3041015		3	3041015B	6
1/2"	6"	1/4" Hex	3041001	3041001C	3	3041001B	6
9/16"	6"	1/4" Hex	3041014		3	3041014B	6
5/8"	6"	1/4" Hex	3041002	3041002C	3	3041002B	6
11/16"	6"	1/4" Hex	3041016		3	3041016B	6
3/4"	6"	1/4" Hex	3041004	3041004C	3	3041004B	6
13/16"	6"	1/4" Hex	3041017		3	3041017B	6
7/8"	6"	1/4" Hex	3041005	3041005C	3	3041005B	6
15/16"	6"	1/4" Hex	3041018		3	3041018B	6
1"	6"	1/4" Hex	3041007	3041007C	3	3041007B	6
1-1/8"	6"	1/4" Hex	3041019		3	3041019B	6
1-1/4"	6"	1/4" Hex	3041009	3041009C	3	3041009B	6
1-3/8"	6"	3/8" Hex	3041020		3	3041020B	6
1-1/2"	6"	3/8" Hex	3041021		3	3041021B	6

Sets

3pc Set SPEEDBOR MAX Speed (5/8", 3/4", 1")	3041003	6	—	—
6pc Set SPEEDBOR MAX Speed (1/2", 5/8", 3/4", 7/8", 1" & 1-1/4")	3041006	6	—	—

Lock-n-Load® Quick Change Extensions

Quick Change Bit Holder 2-1/2" OAL / 5/8" OAW (fits 7/16" - 1-1/4")	1/4"	4935703	6	—	—
Quick Change Bit Holder 6" OAL / 5/8" OAW (fits 7/16" - 1-1/4")	1/4"	4935704	6	—	—
Quick Change Bit Holder 12" OAL / 5/8" OAW (fits 7/16" - 1-1/4")	1/4"	4935705	6	—	—
Quick Change Bit Holder 2-3/4" OAL / 7/8" OAW (fits 1-3/8" & 1-1/2")	3/8"	4935651	6	—	—
Quick Change Bit Holder 5-1/2" OAL / 7/8" OAW (fits 1-3/8" & 1-1/2")	3/8"	4935652	3	—	—
Quick Change Bit Holder 12" OAL / 7/8" OAW (fits 1-3/8" & 1-1/2")	3/8"	4935653	3	—	—

WOOD DRILLING

SPEEDBOR® Spade Bits

SPEEDBOR SPADE BIT FEATURES

1. Double cutting spurs scribe the outside of the hole, reducing breakout.
2. Thicker cutting edge for longer drilling life.
3. Patented BLUE-GROOVE point and cutting edge for faster chip removal.
4. Larger shank for durability.
5. Quick Change shank fits all standard 1/4" quick change chucks.



87912

4-3/4" SPEEDBOR Short Length Spade Bits

- For drilling in tight spaces



88812

6" SPEEDBOR Standard Length Spade Bits

Diameter	Length	Shank Size	Item #	Pack Qty
1/2"	4"	1/4" Hex	87908	6
5/8"	4"	1/4" Hex	87910	6
3/4"	4"	1/4" Hex	87912	6
7/8"	4"	1/4" Hex	87914	6
1"	4"	1/4" Hex	87916	6
1-1/4"	4"	1/4" Hex	87920	3
1-1/2"	4"	1/4" Hex	87924	3

Diameter	Length	Shank Size	Item #	Pack Qty	Bulk Item #	Pack Qty
1/4"	6"	1/4" Hex	88804	6	99904	24
5/16"	6"	1/4" Hex	88805	6	99905	24
3/8"	6"	1/4" Hex	88806	6	99906	24
7/16"	6"	1/4" Hex	88807	6	99907	24
1/2"	6"	1/4" Hex	88808	6	99908	24
9/16"	6"	1/4" Hex	88809	6	99909	24
5/8"	6"	1/4" Hex	88810	6	99910	24
11/16"	6"	1/4" Hex	88811	6	99911	24
3/4"	6"	1/4" Hex	88812	6	99912	24
13/16"	6"	1/4" Hex	88813	6	99913	24
7/8"	6"	1/4" Hex	88814	6	99914	24
15/16"	6"	1/4" Hex	88815	6	99915	24
1"	6"	1/4" Hex	88816	6	99916	24
1-1/8"	6"	1/4" Hex	88818	3	99918	12
1-1/4"	6"	1/4" Hex	88820	3	99920	12
1-3/8"	6"	1/4" Hex	88822	3	99922	12
1-1/2"	6"	1/4" Hex	88824	3	99924	12



88712

16" SPEEDBOR Extra-Long Spade Bits

- For extended reach
- Not for use with bit extensions or drill presses.

Diameter	Length	Shank Size	Item #	Pack Qty	Bulk Item #	Pack Qty
3/8"	16"	1/4" Hex	88706	6	99706	24
1/2"	16"	1/4" Hex	88708	6	99708	24
5/8"	16"	1/4" Hex	88710	6	—	—
3/4"	16"	1/4" Hex	88712	6	99712	24
7/8"	16"	1/4" Hex	88714	6	99714	24
1"	16"	1/4" Hex	88716	6	99716	24

SPEEDBOR® Short Length Spade Bit Sets



1768411

SPEEDBOR Spade Bit Sets



88885



1764344

SPEEDBOR Pro Set



341008

- Sliding latch design provides added security.

Standard Spurless Spade Bits



88012BULK

European Hinge Bits



IW14334

Description	Diameter	Item #	Pack Qty
Short Length Spade Bit Sets			
3-pc set	1/2", 3/4", 1"	87950	6
		87954	
6pc PRO Set w/Extension	3/4", 7/8", 15/16", 1", 1-1/8" & 6" Extension	1768411	6
	Nylon PRO Set Case		
Standard Length Spade Bit Sets			
3pc Set	1/2", 3/4", 1"	88889	6
4pc Set w/Extension	1/2", 3/4", 1", & 6" Quick Change Extension	4935687	6
5pc Set	3/8", 1/2", 5/8", 3/4", 1"	88885	6
6pc Set	3/8", 1/2", 5/8", 3/4", 7/8", 1"	88886	6
6pc Set w/Workshop Rack	3/8", 1/2", 5/8", 3/4", 7/8", 1" & Rack	88888	6
6pc Set w/Slim Case	3/8", 1/2", 5/8", 3/4", 7/8", 1" & Slim Case	88890	6
6pc Set w/Extension	3/8", 1/2", 5/8", 3/4", 1" & 6" Quick Change Extension	88898	6
8pc PRO Set Case	3/8", 1/2", 5/8", 7/8", 1", 1-1/8", 1-1/2" & PRO Set Case	341008	6
13pc Set	1/4", 5/16", 3/8", 7/16", 1/2", 9/16", 5/8", 11/16", 3/4", 13/16", 7/8", 15/16", 1"	88894	6
13pc Set w/Workshop Rack	1/4", 5/16", 3/8", 7/16", 1/2", 9/16", 5/8", 11/16", 3/4", 13/16", 7/8", 15/16", 1"	88887	6
Standard Length Spade Bit Bulk Packs			
4pc Value Pack	5/8"	1764343	6
4pc Value Pack	3/4"	1764344	6
4pc Value Pack	1"	1764345	6
Lock-n-Load® Quick Change Extensions			
1/4" Quick Change Bit Holder 2-1/2" OAL / 5/8" OAW		4935703	6
1/4" Quick Change Bit Holder 6" OAL / 5/8" OAW		4935704	6
1/4" Quick Change Bit Holder 12" OAL / 5/8" OAW		4935705	6
Hex Key Extensions			
1/4" Hex Key Extension 12" OAL		88601	6
1/4" Hex Key Extension 6" OAL		88702	6

Hex Key Extensions compatible with:



Diameter	Length	Shank Size	Bulk Item #	Pack Qty
3/8"	6"	1/4" Hex	88006BULK	24
1/2"	6"	1/4" Hex	88008BULK	24
5/8"	6"	1/4" Hex	88010BULK	24
3/4"	6"	1/4" Hex	88012BULK	24
7/8"	6"	1/4" Hex	88014BULK	24
1"	6"	1/4" Hex	88016BULK	24
1-1/8"	6"	1/4" Hex	88018BULK	24
1-1/4"	6"	1/4" Hex	88020BULK	24
1-1/2"	6"	1/4" Hex	88024BULK	24

Diameter	Length	Shank Size	Bulk Item #	Pack Qty
26 mm	4"	1/4" Round	IW14334	6
35 mm	4"	1/4" Round	IW14335	6

IRWIN® Lock-n-Load® Quick Change Extensions

QUICK CHANGE BIT EXTENSION FEATURES

1. Carbon steel construction sleeve and body for durability and life.
2. Lock-n-Load® system for one-handed quick release.
3. Patented jaw design holds bits securely on 6-flatted shanks, as well as ball detent bits.
4. 1/4" Quick Change range now holds insert bits; magnetic for holding.



4935652



Lock-n-Load Compatibility

WOOD DRILLING

1/4"



- SPEEDBOR Blue Groove (All Sizes)
- SPEEDBOR Max Speed (Sizes 7/16" to 1-1/4")
- Fastener Drive (All products)
- UNIBIT® (Sizes #1, #2, #10, #12)
- 1/4" Hole Saw Arbor (Sizes 9/16" to 1-3/16")
- Countersinks (Sizes #4 to #12)



3/8"



- SPEEDBOR Max Speed (Sizes 1-3/8", 1-1/4")
- UNIBIT (Sizes #3, #4, #11)
- 3/8" Hole Saw Arbor (Sizes 9/16" to 6" diameter saws)



7/16"

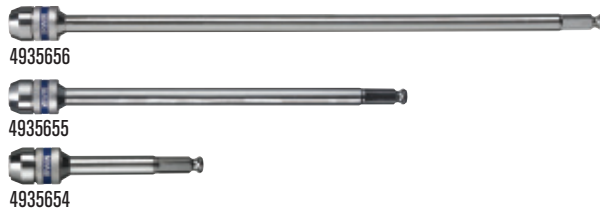

- 17" Ship Augers (Sizes 9/16" and larger)
- 7-1/2" Short Ship Augers (Sizes 1-1/8", 1-1/4")
- Self-Feed Bits (All sizes)
- UNIBIT (Sizes #5, #9, #13, #14, #20, #21)
- 1/2" Hole Saw Arbor (Sizes 1-1/4" - 6")



4935704

Shank Size	Length/Width	Item #	Pack Qty
1/4"	2-1/2" OAL / 5/8" OAW	4935703	6
1/4"	6" OAL / 5/8" OAW	4935704	6
1/4"	12" OAL / 5/8" OAW	4935705	6
3/8"	2-3/4" OAL / 7/8" OAW	4935651	6
3/8"	5-1/2" OAL / 7/8" OAW	4935652	3
3/8"	12" OAL / 7/8" OAW	4935653	3
7/16"	5-1/2" OAL / 1-1/16" OAW	4935654	3
7/16"	12" OAL / 1-1/16" OAW	4935655	3
7/16"	18" OAL / 1-1/16" OAW	4935656	3



88702

Hex Extensions

Shank Size	Length	Item #	Pack Qty
1/4"	12" OAL	88601	6
1/4"	6" OAL	88702	6

Hex Key Extensions
Compatible With:



1/4"
QUICK CHANGE



1/4"
HEX



1/4"
ROUND

Ship Auger Bits

IRWIN revolutionizes cutting and drilling tools with the patent-pending WeldTec™ cutting edge. The new IRWIN SPEEDBOR® with WeldTec Ship Auger Bits are **MADE STRONGER** and **LAST LONGER** because a harder cutting edge is welded to the base material. The result is **2X** longer nail cutting life versus traditional ship auger bits. The superior performance and durability of WeldTec is only available from IRWIN.

SHIP AUGER BIT

FEATURES

1. Patent-pending welded cutting edge for increased durability.
2. Aggressive screw pitch for faster drilling.
3. Wide flutes for maximum chip removal.
4. 7/16" Quick Change impact shank for fast bit changes.

[4] 3043011

2X NAIL CUTTING LIFE*

* Compared to standard IRWIN ship augers
** Fully forged on bits 3/4" diameter and larger



Ship Auger Bits with WeldTec™

- Fully forged bit** for increased durability



1779343

Diameter	Twist Length	Overall Length	Tubed Item #	Pack Qty	Bulk Item #	Pack Qty
7.5" Ship Augers with WeldTec™						
3/8"	5"	7-1/2"	1779135	1	-	-
7/16"	5"	7-1/2"	1779136	1	-	-
1/2"	5"	7-1/2"	1779137	1	-	-
9/16"	5"	7-1/2"	1779138	1	-	-
5/8"	5"	7-1/2"	1779139	1	-	-
11/16"	5"	7-1/2"	1779140	1	-	-
3/4"	5"	7-1/2"	1779341	1	-	-
13/16"	5"	7-1/2"	1779342	1	-	-
7/8"	5"	7-1/2"	1779343	1	-	-
15/16"	5"	7-1/2"	1779344	1	-	-
1"	5"	7-1/2"	1779345	1	-	-
1-1/16"	5"	7-1/2"	1779346	1	-	-
1-1/8"	5"	7-1/2"	1779347	1	-	-
1-1/4"	5"	7-1/2"	1779348	1	-	-
1-3/8"	5"	7-1/2"	1779349	1	-	-
1-1/2"	5"	7-1/2"	1779350	1	-	-



3043011

Diameter	Twist Length	Overall Length	Tubed Item #	Pack Qty	Bulk Item #	Pack Qty
17" Ship Augers with WeldTec™						
3/8"	12"	17"	3043004	1	3043004B	6
7/16"	12"	17"	4935570	1	4935571	6
1/2"	12"	17"	3043005	1	3043005B	6
9/16"	12"	17"	3043006	1	3043006B	6
5/8"	12"	17"	3043007	1	3043007B	6
11/16"	12"	17"	3043008	1	3043008B	6
3/4"	12"	17"	3043009	1	3043009B	6
13/16"	12"	17"	3043010	1	3043010B	6
7/8"	12"	17"	3043011	1	3043011B	6
15/16"	12"	17"	3043012	1	3043012B	6
1"	12"	17"	3043013	1	3043013B	6
1-1/16"	12"	17"	4935572	1	4935573	6
1-1/8"	12"	17"	3043014	1	3043014B	3
1-1/4"	12"	17"	3043015	1	3043015B	3
1-3/8"	12"	17"	4935574	1	4935575	3
1-1/2"	12"	17"	3043016	1	3043016B	3

WOOD DRILLING

Wood Drilling

Hollow Center Auger Bits



46616



Utility Pole Auger Bits

- Extra-long twist is ideal for drilling large poles, construction timbers, and for other timber applications.
- Cutting spur scribes the outside of the hole during drilling for a smooth, clean hole.
- Remove the taper square shank and use in an electric drill or hand brace.
- Bit can be resharpened.
- Medium-fast screw point ideal for general wood drilling applications.

Diameter	Shank Type	Twist Length	Overall Length	Bulk Item #	Pack Qty.
3/8"	Taper square	12"	18"	46606	6
7/16"	Taper square	12"	18"	46607	6
1/2"	Taper square	12"	18"	46608	6
9/16"	Taper square	12"	18"	46609	6
5/8"	Taper square	12"	18"	46610	6
11/16"	Adapter shank	12"	18"	46611	6
3/4"	Adapter shank	12"	18"	46612	6
13/16"	Adapter shank	12"	18"	46613ZR	6
7/8"	Adapter shank	12"	18"	46614	6
15/16"	Adapter shank	12"	18"	46615	6
1"	Adapter shank	12"	18"	46616	6
1-1/16"	7/16" hex	12"	18"	46617	3
11/16"	7/16" hex	18"	24"	46711	6
13/16"	7/16" hex	18"	24"	46713ZR	6
1"	7/16" hex	18"	24"	46716	6

Adapter Shank

Fits both hand braces and power drills



Taper square shank fits hand braces



Cut off or square and use in both power drills and hand braces

WOOD DRILLING



47915



Utility Pole Auger Bits – Impact Shank

- Extra-long twist is ideal for drilling large poles, construction timbers, and for other timber applications.
- Cutting spur scribes the outside of the hole during drilling for a smooth, clean hole.
- Hex shank design for use in impact wrench drills.
- Bit can be resharpened.
- Medium-fast screw point ideal for general wood drilling applications.

Diameter	Shank Size	Twist Length	Overall Length	Bulk Item #	Pack Qty.
13/16"	5/8"	15"	18"	48113	6
11/16"	5/8"	15"	18"	48111ZR	6
9/16"	5/8"	15"	18"	48109	6
1-1/16"	7/16"	15"	18"	47917	3
15/16"	7/16"	15"	18"	47915	6
13/16"	7/16"	15"	18"	47913	6
11/16"	7/16"	15"	18"	47911	6
9/16"	7/16"	15"	18"	47909	6
1-1/16"	5/8"	21"	24"	48317	3
15/16"	5/8"	21"	24"	48315	3
13/16"	5/8"	21"	24"	48313	6
11/16"	5/8"	21"	24"	48311	6
15/16"	7/16"	21"	24"	48215	3
13/16"	7/16"	21"	24"	48213ZR	6
11/16"	7/16"	21"	24"	48211	6



47016



Pole Auger Bits – Hex Shank

- Extra-long twist is ideal for drilling in large poles, construction timbers, and for multiple timber applications.
- All bits feature 7/16" adaptable hex shank. Simply remove it to use round shank.
- Bit can be resharpened.
- Medium-fast screw point is ideal for general wood drilling applications.
- Cutting spur scribes the outside of the hole during drilling for a smooth, clean hole.

Diameter	Twist Length	Overall Length	Bulk Item #	Pack Qty
9/16"	12"	17"	46809	6
5/8"	12"	17"	46810	6
11/16"	12"	17"	46811	6
3/4"	12"	17"	46812	6
13/16"	12"	17"	46813	6
9/16"	12"	23"	46909	6
5/8"	18"	23"	46910	6
11/16"	18"	23"	46911	6
3/4"	18"	23"	46912	6
13/16"	18"	23"	46913ZR	6
7/8"	18"	23"	46914ZR	6
15/16"	18"	23"	46915ZR	3
9/16"	24"	29"	47009	6
5/8"	24"	29"	47010	6
11/16"	24"	29"	47011	6
3/4"	24"	29"	47012	6
13/16"	24"	29"	47013	6
7/8"	24"	29"	47014	6
15/16"	24"	29"	47015	3
1"	24"	29"	47016	3
1-1/16"	24"	29"	47017	3



48715



Ship Auger Bits – Impact Shank

- Hex shank design for use in impact wrench drills.
- Bit can be resharpened.
- Medium-fast screw point ideal for general wood drilling applications.

Diameter	Shank Size	Twist Length	Overall Length	Bulk Item #
1/2"	7/16"	9"	12"	48508
9/16"	7/16"	9"	12"	48509
11/16"	7/16"	9"	12"	48511
13/16"	7/16"	9"	12"	48513
9/16"	5/8"	9"	12"	48609ZR
9/16"	7/16"	15"	18"	48709
11/16"	7/16"	15"	18"	48711
13/16"	7/16"	15"	18"	48713
15/16"	7/16"	15"	18"	48715
1-1/16"	7/16"	15"	18"	48717



49916



Solid Center Auger with Cutting Spur – I-100 Series

- Solid center design provides extra rigidity while drilling.
- Wide lands keep the bit straight as it bores through the hole. The flutes are ground behind the lands to funnel chips to the inside of the bit and away from the outside diameter, producing a faster, cleaner cut.
- Single-spur cutting edge scribes the circumference of the hole for a smoother finish.
- Coarse screw point provides fast drilling in hard and soft woods.
- Full-length, heat-treated bit guards against bending in heavy-duty applications, and strengthens the twist where the greatest strain occurs.

Diameter	Shank Size	Twist Length	Overall Length	Bulk Item #	Pack Qty
1/4"	3/16"	4-1/2"	7-1/2"	49904	1
5/16"	7/32"	4-1/2"	7-1/2"	49905	1
3/8"	5/16"	4-1/2"	7-1/2"	49906	1
7/16"	5/16"	4-1/2"	7-1/2"	49907	1
1/2"	5/16"	4-1/2"	7-1/2"	49908	1
9/16"	5/16"	4-1/2"	7-1/2"	49909	1
5/8"	5/16"	4-1/2"	7-1/2"	49910	1
11/16"	5/16"	4-1/2"	7-1/2"	49911	1
3/4"	5/16"	4-1/2"	7-1/2"	49912	1
13/16"	5/16"	4-1/2"	7-1/2"	49913	1
7/8"	5/16"	4-1/2"	7-1/2"	49914	1
15/16"	5/16"	4-1/2"	7-1/2"	49915	1
1"	5/16"	4-1/2"	7-1/2"	49916	1
1-1/8"	7/16"	4-1/2"	7-1/2"	49918	1
1-1/4"	7/16"	4-1/2"	7-1/2"	49920	1
1-3/8"	7/16"	4-1/2"	7-1/2"	49922	1
1-1/2"	7/16"	4-1/2"	7-1/2"	49924	1

Solid Center Auger Bit Sets

6-pc pouched contains 1/4", 3/8", 1/2", 5/8", 3/4" & 1"	49998	1
3-pc pouched contains 1/4", 3/8", & 1/2"	49999	6

Description	Overall Length	Item #	Pack Qty
Hex Key Extensions			
5/16" Hex Key Extension	18"	43805	1
7/16" Hex Key Extension	18"	43907	1

WOOD DRILLING



43616

Hand Brace Solid Center Auger Bits – 62T Series

- Medium-fast screw point is ideal for general wood drilling applications.
- Full-length, heat-treated bit guards against bending in heavy-duty applications, and strengthens the twist where the greatest strain occurs.
- Double spur, double cutter design leaves an extremely clean hole finish.

Diameter	Shank Type	Twist Length	Overall Length	Pouched Item #	Bulk Item #
1/4"	Taper square	3-1/2"	7-1/2"	43604	—
5/16"	Taper square	3-5/8"	7-5/8"	43605	—
3/8"	Taper square	3-3/4"	7-3/4"	43606	—
7/16"	Taper square	3-7/8"	7-7/8"	43607	—
1/2"	Taper square	4"	8"	43608	—
9/16"	Taper square	4-1/8"	8-1/8"	43609	—
5/8"	Taper square	4-1/4"	8-1/4"	43610ZR	—
11/16"	Taper square	4-3/8"	8-3/8"	43611	—
3/4"	Taper square	4-1/2"	8-1/2"	43612	—
13/16"	Taper square	4-5/8"	8-5/8"	43613ZR	—
7/8"	Taper square	4-9/16"	8-3/4"	43614	—
15/16"	Taper square	4-11/16"	8-7/8"	43615	—
1"	Taper square	4-13/16"	9"	43616	—
1-1/2"	Taper square	4-7/8"	9-1/2"	—	43624
13-pc Pouch	—	—	—	—	43697



45516



**Drilling Machine Auger Bits –
62R Series, 1/2" Round Shank**

- Round shank is designed for use in power drills, drill presses, and drilling machines with 1/2" or larger chuck.
- Heavy stem increases strength and rigidity while reducing vibration. Shank length is 2".
- Medium-fast screw point is ideal for general wood drilling applications.

Diameter	Twist Length	Overall Length	Bulk Item #
7/16"	6"	8"	45307
1/2"	6"	8"	45308
9/16"	6"	8"	45309
11/16"	6"	8"	45311
3/4"	6"	8"	45312
13/16"	6"	8"	45313
7/8"	6"	8"	45314
1"	6"	8"	45316
3/8"	8"	10"	45406
7/16"	8"	10"	45407
9/16"	8"	10"	45409
11/16"	8"	10"	45411
3/4"	8"	10"	45412
13/16"	10"	12"	45513
1"	10"	12"	45516
3/8"	12"	14"	45606
1/2"	12"	14"	45608
11/16"	12"	14"	45611
3/4"	12"	14"	45612
13/16"	12"	14"	45613
7/8"	12"	14"	45614
1"	12"	14"	45616

WOOD DRILLING



38912

Wood Installer Bits

- Constructed of premium alloy steel for drilling into a variety of materials including wood, plaster, and metal lath encountered while installing wire.
- Special 82° point for fast drilling.
- Hole in flute makes it easy to pull wire through walls, ceilings, and floors.
- Ideal for installation of small wire for telephones, cable TV, computers, and security systems.

Diameter	Shank Size	Overall Length	Item #	Bulk Item #
1/4"	.230"	12"	—	38904
5/16"	.285"	12"	—	38905
3/8"	.370"	12"	—	38906
1/2"	.370"	12"	—	38908
9/16"	.370"	12"	—	38909
5/8"	.370"	12"	—	38910
3/4"	.370"	12"	—	38912
1/4"	.230"	18"	39104	39004
5/16"	.285"	18"	39105	39005
3/8"	.370"	18"	39106	39006
7/16"	.370"	18"	39107ZR	39007
1/2"	.370"	18"	39108ZR	39008
9/16"	.370"	18"	39109ZR	—
5/8"	.370"	18"	39110	39010
11/16"	.370"	18"	39111	—
3/4"	.370"	18"	39112	—
1/4"	.230"	24"	—	39404
5/16"	.285"	24"	—	39405
3/8"	.370"	24"	—	39406
1/2"	.370"	24"	—	39408
1/4"	.230"	30"	—	39604
3/8"	.370"	30"	—	39606
1/2"	.370"	30"	—	39608
Installer Bit Sets				
3-pc Set 1/4", 3/8", 1/2"	—	—	—	3044001LW

WOOD DRILLING



40012

Carbide Tip Installer Bits

- Hole in flute makes it easy to pull wire through walls, ceilings, and floors.
- Specially designed flute quickly clears masonry dust.
- Heavy duty 118° point enters material quickly.
- Carbide tip cutting edge ideal for use where masonry construction is encountered including brick, mortar joints, and cinder blocks.

Diameter	Shank Size	Overall Length	Bulk Item #
1/4"	.245"	18"	40004ZR
5/16"	.250"	18"	40005
3/8"	.370"	18"	40006
1/2"	.370"	18"	40008
5/8"	.370"	18"	40010
3/4"	.370"	18"	40012



45002

Adjustable Wood Bits

- Adjustable cutting blade bores a variety of hole sizes.
- Cuts 19 hole sizes in increments of 1/8".
- Lockhead screw securely holds blade at desired drilling diameter.

Diameter	Shank Size	Usage	Overall Length	Item #
5/8" - 1-3/4"	9/32"	Drill Press / Hand Brace	5-1/2"	44801
7/8" - 3"	11/32"	Drill Press / Hand Brace	6-1/2"	45002
7/8" - 3"	—	Hand Brace	6-1/2"	44202

SPEEDBOR MAX SELF-FEED BIT

FEATURES

1. 3X cutting edges* extends bit life
2. Aggressive screw pitch for faster drilling
3. 7/16" Quick Change impact shank for fast bit changes

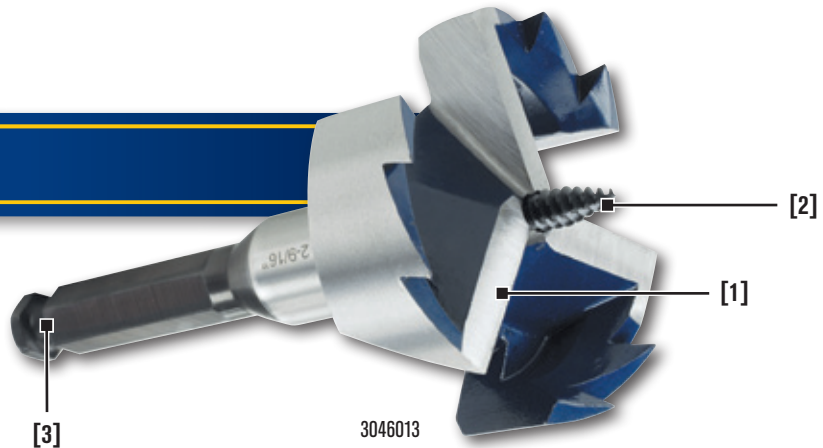

SPEEDBOR Max Self-Feed Wood Bits

- For drilling large diameter holes in wood for pipe, conduit and other applications
- Precision-milled shank eliminates runout and wobble.
- Replaceable screw tip
- Resharpenable edges

*2 cutting edges on sizes 3" and larger

Diameter	Shank Size	Overall Length	Pack Qty.	Item #
1"	7/16"	5"	1	3046004
1-1/8"	7/16"	5"	1	3046005
1-1/4"	7/16"	5"	1	3046006
1-3/8"	7/16"	5"	1	3046007
1-1/2"	7/16"	5"	1	3046008
1-3/4"	7/16"	5"	1	3046009
2"	7/16"	5"	1	3046010
2-1/8"	7/16"	5"	1	3046011
2-1/4"	7/16"	5"	1	3046012
2-9/16"	7/16"	5"	1	3046013
3"	7/16"	5"	1	3046014
3-5/8"	7/16"	5"	1	3046015
4-5/8"	7/16"	5"	1	3046016

Lock-n-Load® Quick Change Extensions

7/16" Quick Change Bit Holder 5-1/2" OAL / 1-1/16" OAW	3	4935654
7/16" Quick Change Bit Holder 12" OAL / 1-1/16" OAW	3	4935655
7/16" Quick Change Bit Holder 18" OAL / 1-1/16" OAW	3	4935656

Replacement Tips - Includes (5) Screw Tips, (5) Set Screws, and (1) Hex Key

Self-feed tips 1" - 1-3/8" bits	6	1792762
Self-feed tips 1-1/2" - 2-9/16" bits	6	1792763
Self-feed tips 3" - 4-5/8" bits	6	1792764



49618

Brad Point Bits

- Brad point tip provides accurate positioning for starting the hole.
- Bit is precision-ground for use in furniture making, doweling, cabinetry, and other woodworking applications where an exact hole size is required.
- Spur cutting edges reduce splintering and ensure a smooth, clean hole.
- Wide flutes provide a fast, continuous flow of chip ejection.

Diameter	Shank Size	Twist Length	Overall Length	Item #
1/8"	1/8"	1-7/16"	2-9/16"	49612
3/16"	3/16"	2-1/16"	3-3/8"	49613
1/4"	1/4"	2-1/2"	3-31/32"	49614
5/16"	5/16"	2-15/16"	4-19/32"	49615
3/8"	3/8"	3-7/16"	5-1/4"	49616
7/16"	3/8"	3-11/16"	5-19/32"	49617
1/2"	3/8"	3-31/32"	5-15/16"	49618

Brad Point Drill Bit Set

5-pc pouched set contains 3/16", 1/4", 5/16", 3/8" & 1/2"	49600
---	-------

Wood Drilling

Forstner Bits / Plug Cutters / Countersinks

Forstner Bits



42916

- Reduced shank fits 3/8" portable drills and drill presses.
- Brad point tip starts the bit cleanly on uneven surfaces.

Forstner Bit Set



42940

Diameter	Shank Size	Item #
1/4"	3/8"	42904
3/8"	3/8"	42906
1/2"	3/8"	42908
5/8"	3/8"	42910
3/4"	3/8"	42912
7/8"	3/8"	42914
1"	3/8"	42916
1-1/8"	3/8"	42918
1-1/4"	3/8"	42920
1-3/8"	3/8"	42922
1-1/2"	3/8"	42924
1-5/8"	3/8"	42926
1-3/4"	3/8"	42928
1-7/8"	3/8"	42930
2"	3/8"	42932
2-1/8"	3/8"	42934
4" Extension	3/8"	42936
European Hinge Forstner Bit		
35mm	3/8"	4935685
Forstner Bit Set		
4-pc Set contains 5/8", 3/4", 7/8", 1"		42940

WOOD DRILLING

Plug Cutters



43910

- Recommended for covering fastener holes in furniture, cabinetry, floors, decks, and other woodworking projects.
- Constructed of hardened, high-carbon steel for added strength and durability.
- Ideal for making dowels.

Diameter	Shank Size	Item #
1/4"	1/4"	43904
3/8"	1/4"	43906
1/2"	1/4"	43908
5/8"	1/4"	43910

Adjustable Countersinks



90583

Description	Counterbore Diameter	Drill Bit Size	Item #
#4 - 5 Countersink	3/8"	5/64"	90581
#6 - 7 Countersink	3/8"	3/32"	90582
#8 - 9 Countersink	3/8"	7/64"	90583
#10 Countersink	3/8"	1/8"	90584
#12 Countersink	1/2"	9/64"	90585